

Proportional spool valve

Flange construction

- ◆ $Q_{max} = 42 \text{ l/min}$
- ◆ 4 volume flow levels
- ◆ $Q_{Nmax} = 32 \text{ l/min}$
- ◆ $p_{max} = 350 \text{ bar}$

NG6
ISO 4401-03

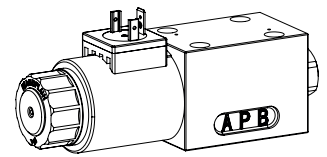

DESCRIPTION

Direct operated proportional spool valve with 4 connections in 5-chamber system. Precise spool fit, low leakage, long service life time. The volume flow adjustment takes place by a Wandfluh proportional solenoid. Proportional to the solenoid current, the spool stroke, the spool opening and the valve volume flow increase. For the control, Wandfluh proportional amplifiers are available (see register 1.13).

APPLICATION

Proportional spool valves are perfectly suitable for demanding tasks due to the high resolution, large volume flow and low hysteresis. The applications are in the industry as well as in the mobile hydraulics for the smooth control of hydraulic actuators. Some examples: control of the rotor blades of wind generators, forestry and earth moving machines, machine tools and paper production machines, simple position controls, robotics and fan control.

SYMBOL

Symmetrical control

ACB-S

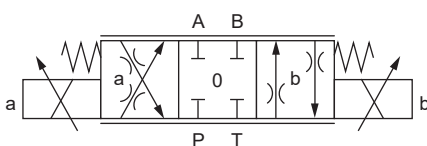

AC1-S

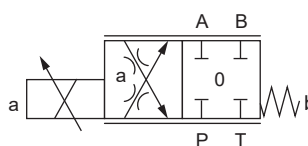

CB2-S

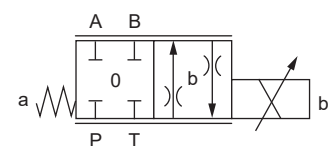

Meter-in control

ADB-V

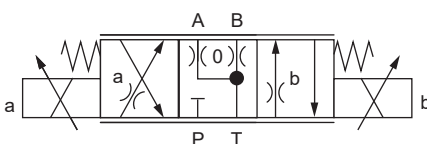

AD1-V

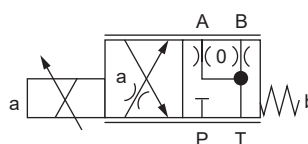

DB2-V

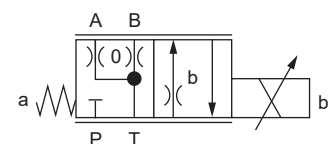

GENERAL SPECIFICATIONS

Designation	Proportional spool valve
Construction	Direct operated
Mounting	Flange construction
Nominal size	NG6 according to ISO 4401-03
Actuation	Proportional solenoid
Ambient temperature	-25...+70 °C if >50 °C, I_G is only conditionally achievable
Weight	1,5 kg (1 solenoid) 2,0 kg (2 solenoids)

ACTUATION

Actuation	Proportional solenoid, wet pin push type, pressure tight
Execution	W.E45 / 23 x 50 (Data sheet 1.1-182) M.S45 / 23 x 50 (Data sheet 1.1-181)
Connection	Connector socket EN 175301 – 803 Connector socket AMP Junior-Timer Connector Deutsch DT04 – 2P

TYPE CODE

		WD P F A06 - <input type="text"/> - <input type="text"/> - <input type="text"/> / <input type="text"/> <input type="text"/> - <input type="text"/> <input type="text"/> <input type="text"/> # <input type="text"/>									
Spool valve, direct operated											
Proportional											
Flange construction											
International standard interface ISO, NG6											
Designation of symbols acc. to table											
Nominal volume flow rate Q_N	5 l/min	<input type="text" value="5"/>	16 l/min	<input type="text" value="16"/>							
	10 l/min	<input type="text" value="10"/>	32 l/min	<input type="text" value="32"/>							
Nominal voltage U_N	12 VDC	<input type="text" value="G12"/>	24 VDC	<input type="text" value="G24"/>							
	without coil	<input type="text" value="X5"/>									
Slip-on coil	Metal housing, round			<input type="text" value="W"/>							
	Metal housing, square			<input type="text" value="M"/>							
Connection execution	Connector socket EN 175301-803 / ISO 4400			<input type="text" value="D"/>							
	Connector socket AMP Junior-Timer			<input type="text" value="J"/>							
	Connector Deutsch DT04 - 2P			<input type="text" value="G"/>							
Sealing material	NBR			<input type="text"/>							
	FKM (Viton)			<input type="text" value="D1"/>							
Manual override	Integrated			<input type="text"/>							
	Push-button			<input type="text" value="HF1"/>							
	Spindle			<input type="text" value="HS1"/>							
Surface protection	Standard			<input type="text"/>							
	Zinc-nickel			<input type="text" value="K8"/>							
Design index (subject to change)											

1.10-77

ELECTRICAL SPECIFICATIONS

Protection class	Connection execution D: IP65 Connection execution J: IP66 Connection execution G: IP67 and IP69K
Relative duty factor	100 % DF
Standard nominal voltage	12 VDC, 24 VDC
Limiting current at 50 °C	$I_G = 930 \text{ mA}$ ($U_N = 24 \text{ VDC}$) $I_G = 1690 \text{ mA}$ ($U_N = 12 \text{ VDC}$)

Note!

Other electrical specifications see data sheet 1.1-182 (slip-on coil W) and 1.1-181 (slip-on coil M)

HYDRAULIC SPECIFICATIONS

Working pressure	$p_{\max} = 350 \text{ bar}$
Tank pressure	$p_{T\max} = 250 \text{ bar}$
Maximum volume flow	$Q_{\max} = 42 \text{ l/min}$, see characteristics
Nominal volume flow	$Q_N = 5 \text{ l/min}$, 10 l/min, 16 l/min, 32 l/min
Leakage oil	On request
Hysteresis	$\leq 5 \%$ at optimal dither signal
Fluid	Mineral oil, other fluid on request
Viscosity range	12 mm ² /s...320 mm ² /s
Temperature range fluid	-25...+70 °C (NBR) -20...+70 °C (FKM)
Contamination efficiency	Class 18 / 16 / 13
Filtration	Required filtration grade $\beta_{6...10} \geq 75$, see data sheet 1.0-50

PERFORMANCE SPECIFICATIONS

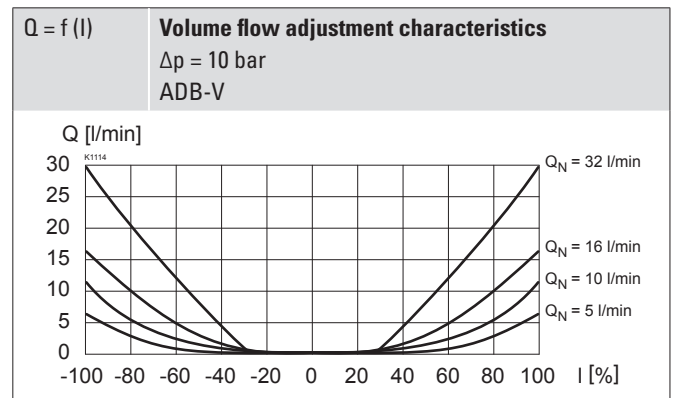
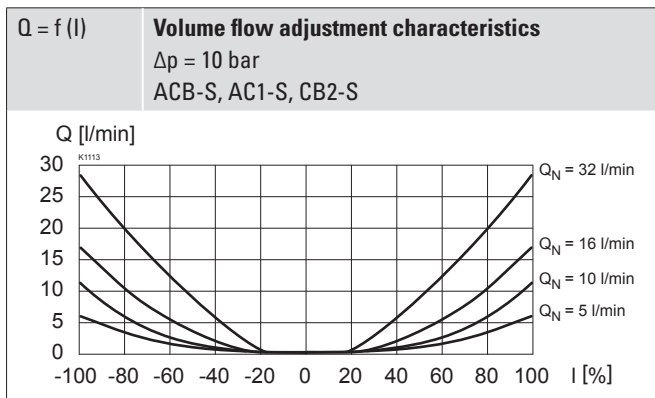
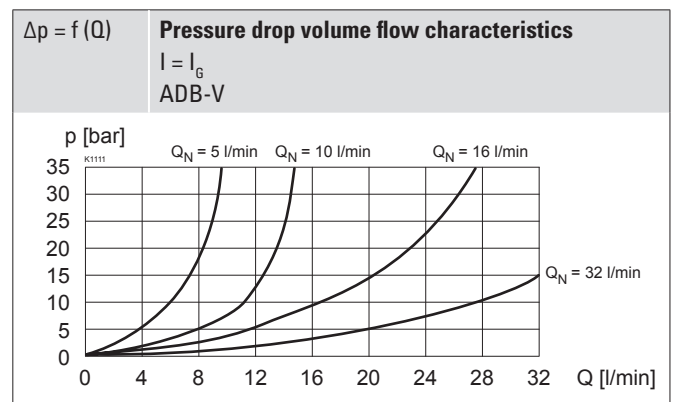
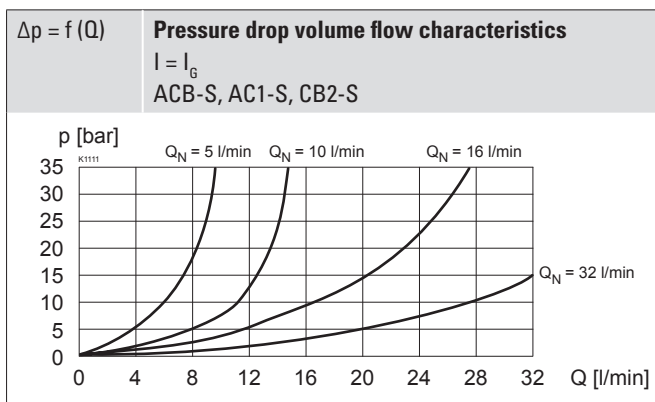
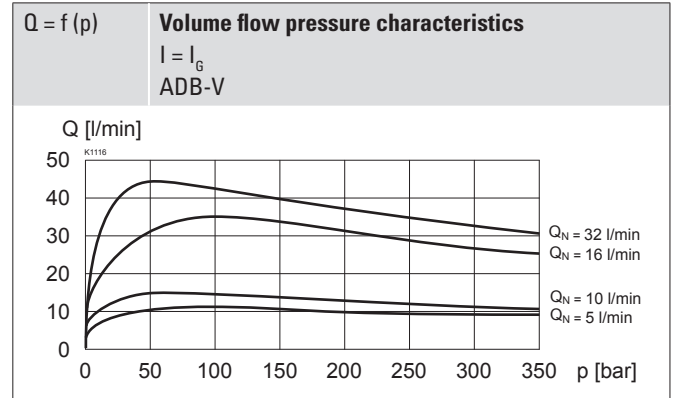
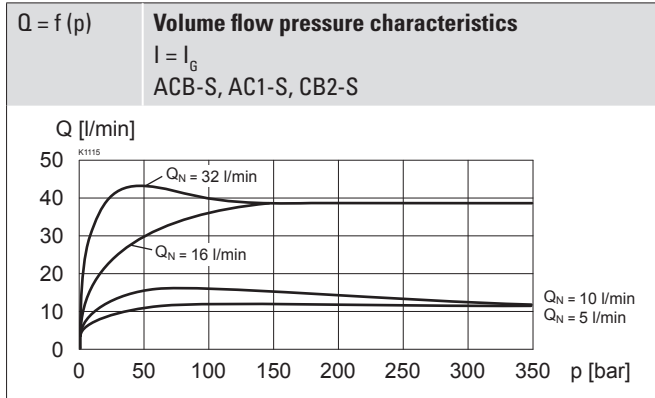
 Oil viscosity $\nu = 30 \text{ mm}^2/\text{s}$

Note! All values were measured over two control edges. The connections A and B were short-circuited.



DIMENSIONS

4/3-way spool valve (spring centred)

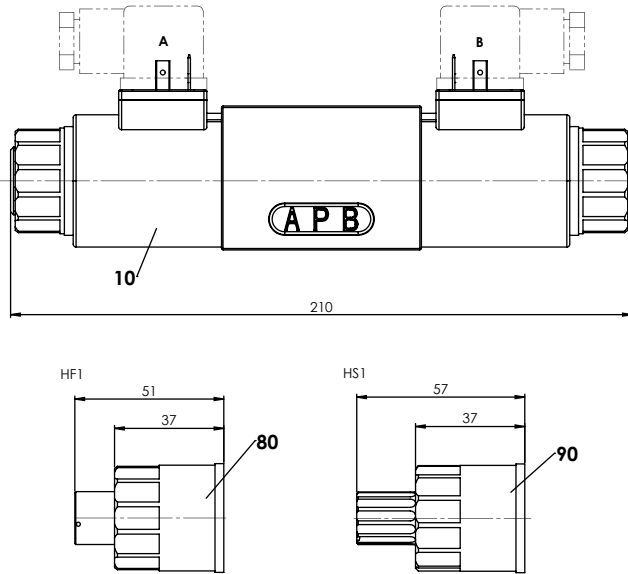

4/2-way spool valve

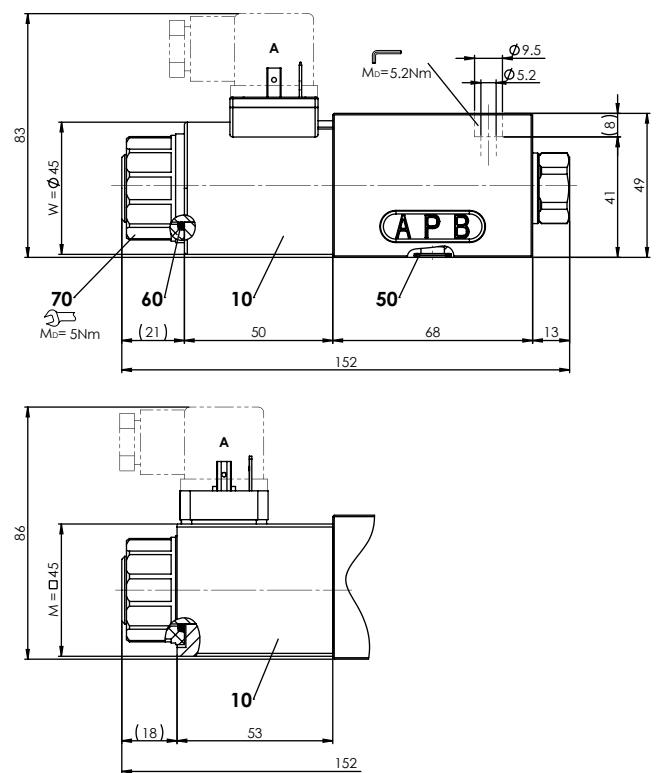
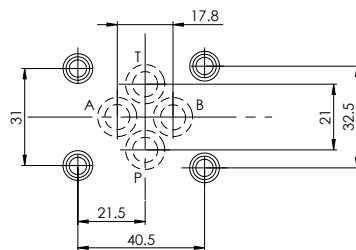
HYDRAULIC CONNECTION

MANUAL OVERRIDE

- ◆ Integrated (-) Actuation pin integrated in the armature tube. Actuation by pressing the pin
- ◆ Push-button (HF1) Integrated in the knurled nut. Actuation by pressing the push-button
- ◆ Spindle (HS1) Integrated in the knurled nut. Actuation by turning the spindle (continuously variable valve actuation)

Attention! The actuation of the manual override is possible up to a tank pressure of:

- 160 bar Integrated (-)
- 160 bar Push-button (HF1)
- 250 bar Spindle (HS1)

PARTS LIST

Position	Article	Description
10	206.1...	W.E45 / 23 x 50
	206.7...	M.S45 / 23 x 50
70	154.2701	Knurled nut M23 x 1,5 x 19,7
80	253.7004	HF1-M23
90	253.7002	HS1-M23

Seal kit consisting of

50	O-ring	ID 9,25 x 1,78
60	O-ring	ID 22,22 x 2,62

ACCESSORIES

Mating connector grey (A)	Article no. 219.2001
Mating connector black (B)	Article no. 219.2002
Fixing screws	Data sheet 1.0-60
Threaded subplates	Data sheet 2.9-30
Multi-station subplates	Data sheet 2.9-60
Horizontal mounting blocks	Data sheet 2.9-100
Technical explanations	Data sheet 1.0-100
Filtration	Data sheet 1.0-50
Relative duty factor	Data sheet 1.1-430
Proportional amplifier	Register 1.13

SURFACE TREATMENT

The valve body, the armature tube, the slip-on coil and the screw plug are zinc-nickel coated.

ISO 9227 (800 h) salt spray test

INSTALLATION NOTES

Mounting type	Flange mounting 4 fixing holes for socket head screws M5 x 50
Mounting position	Any, preferably horizontal
Tightening torque	Fixing screws $M_0 = 5,2 \text{ Nm}$ (screw quality 8.8, zinc coated) $M_0 = 5 \text{ Nm}$ knurled nut

Note!



The length of the fixing screw depends on the base material of the connection element.

SEALING MATERIAL

NBR or FKM (Viton) as standard, choice in the type code

STANDARDS

Mounting interface	ISO 4401-03
Solenoids	DIN VDE 0580
Connection execution D	EN 175301 – 803
Protection class	EN 60 529
Contamination efficiency	ISO 4406