

Poppet valve

Flange construction

- ◆ pneumatically operated
- ◆ 2/2-, 3/2- and 3/4-way
- ◆ normally open and normally closed
- ◆ $Q_{max} = 15 \text{ l/min}$
- ◆ $p_{max} = 350 \text{ bar}$

NG4-Mini Wandfluh standard

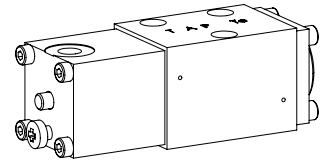

DESCRIPTION

Direct operated 2/2-, 3/2 and 3/4-way poppet valve in flange construction. By means of the pneumatic actuation control head, the poppet valve spool is opened or closed acting against the spring. Due to the poppet spool construction with pressure compensation on both sides, the flow through the valve is possible in both directions. The seat spool guide is sealed by means of an O-ring. The metallic sealing seat closes the valve virtually leak free.

APPLICATION

Poppet valves are used where tight closing functions of the valve are essential like leakage-free load holding, clamping or gripping. Miniature valves are used where both, reduced dimensions and weight are important.

SYMBOL

BK22040b

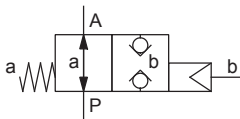

BK22041a

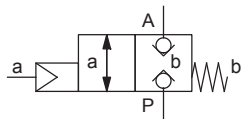

BK32040b

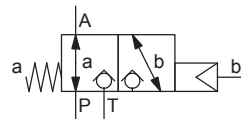

BK32041a

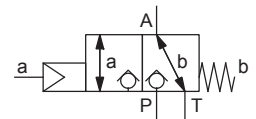

BK3404

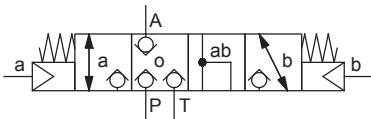

TYPE CODE

2/2 or 3/2 way execution
 3/4 way execution

B K 2 04 - #
 B K 3 4 04 - #

Mounting interface acc. to Wandfluh standard

Pneumatically operated

2 way (connections) 2
 3 way (connections) 3

2 switching positions
 4 switching positions

Nominal size 4-Mini

Normally closed Pilot head on A-side 1a
 Normally open Pilot head on B-side 0b

Sealing material NBR
 FKM (Viton) D1

Design index (subject to change)

1.11-6120

GENERAL SPECIFICATIONS

Designation	2/2-, 3/2- and 3/4-way poppet valve
Construction	Direct operated
Mounting	Flange construction
Nominal size	NG4-Mini according to Wandfluh standard
Actuation	Pneumatically operated
Ambient temperature	-25...+70 °C (NBR) -20...+70 °C (FKM)
Weight	0,9 kg (2/2- et 3/2-way) 1,2 kg (3/4-way)
MTTFd	150 years

PERFORMANCE SPECIFICATIONS

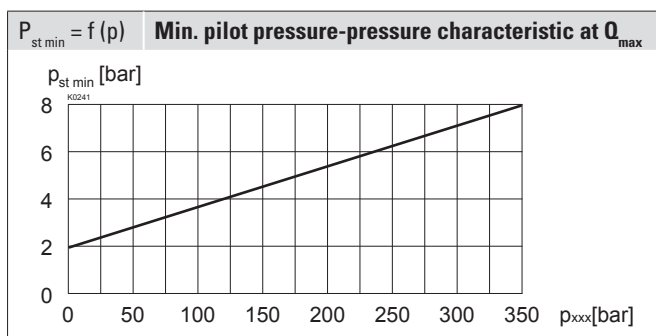
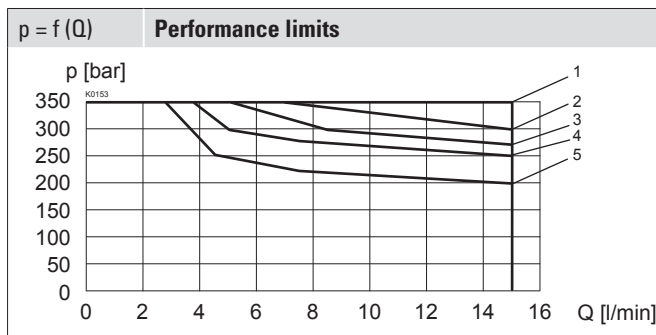
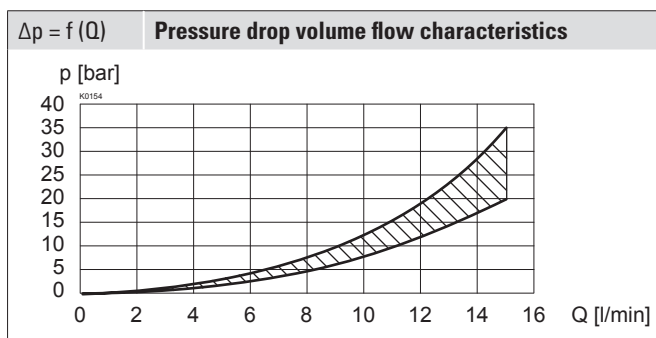
 Oil viscosity $\nu = 30 \text{ mm}^2/\text{s}$

ACTUATION

Actuation	Pneumatically
Execution	Actuation BKII
Pilot pressure	$p_{st \min}$ = see characteristic $p_{st \max} = 8 \text{ bar}$
Control volume	$V = 2,5 \text{ cm}^3$

HYDRAULIC SPECIFICATIONS

Working pressure	$p_{\max} = 350 \text{ bar}$
Maximum volume flow	$Q_{\max} = 15 \text{ l/min}$, see characteristic
Volume flow direction	Any (see characteristic)
Leakage oil	Seat tight, max. 0,05 ml / min (approx. 1 drop / min) at 30 cSt
Fluid	Mineral oil, other fluid on request
Viscosity range	12 mm ² /s...320 mm ² /s
Temperature range fluid	-20...+70 °C
Contamination efficiency	Class 20 / 18 / 14
Filtration	Required filtration grade $\beta_{10...16} \geq 75$, see data sheet 1.0-50

Type	Flow direction			
	P - A	A - T	A - P	T - A
BK22041a	1	-	2	-
BK22040b	1	-	4	-
BK32041a	1	3	5	1
BK32040b	1	4	5	1
BK3404	1	1	2	2

VALVES INSTALLED

The central functioning element is the poppet valve cartridge NG4, data sheet 1.11-2020.

DIMENSIONS

3/2-; 2/2-way

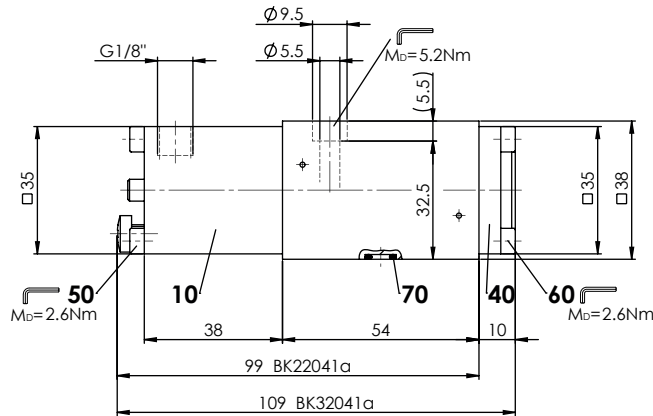

3/2-; 2/2-way

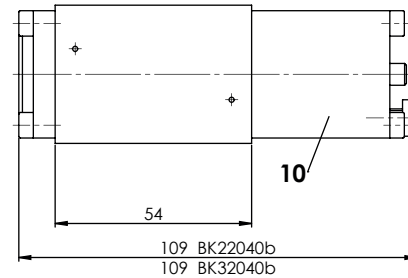

3/4-way

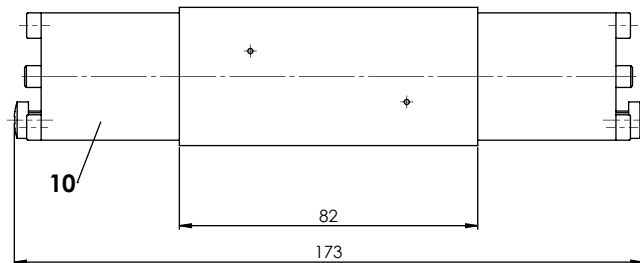

HYDRAULIC CONNECTION

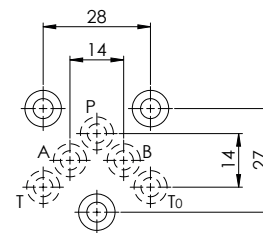

PARTS LIST

Position	Article	Description
10	254.2000	Pneumatic actuation BK II
40	057.4201	Cover
50	246.1146	Socket head screw M4 x 45 DIN 912
60	246.1113	Socket head screw M4 x 12 DIN 912
70	160.2052	O-ring ID 5,28 x 1,78 (NBR)
	160.6052	O-ring ID 5,28 x 1,78 (FKM)

SURFACE TREATMENT

- ◆ The valve body is painted with a two component paint
- ◆ The pneumatic actuation, the cover and the socket head screws are zinc coated

INSTALLATION NOTES

Mounting type	Flange mounting 3 fixing holes for socket head screws M5 x 40
Mounting position	Any, preferably horizontal
Tightening torque	Fixing screws $M_D = 5,2 \text{ Nm}$ (screw quality 8.8, zinc coated)

Note!



The length of the fixing screw depends on the base material of the connection element.

ACCESSORIES

Fixing screws	Data sheet 1.0-60
Threaded subplates	Data sheet 2.9-10
Multi-station subplates	Data sheet 2.9-50
Module type manifold blocks	Data sheet 2.9-90
Technical explanations	Data sheet 1.0-100
Filtration	Data sheet 1.0-50

SEALING MATERIAL

NBR or FKM (Viton) as standard, choice in the type code

MANUAL OVERRIDE

In mechanical control head integrated. Actuation by pressing the pin

STANDARDS

Mounting interface	Wandfluh standard
Contamination efficiency	ISO 4406

Wandfluh AG Postfach CH-3714 Frutigen
 Tel. +41 33 672 72 72 Fax +41 33 672 72 12 sales@wandfluh.com