

Solenoid operated spool valve for the temperature range -60 °C

Flange construction

- ◆ 4/2-way impulse valve
- ◆ 4/3-way with spring centred mid position
- ◆ 4/2-way with spring reset
- ◆ $Q_{max} = 50 \text{ l/min}$
- ◆ $p_{max} = 350 \text{ bar}$

NG6 ISO 4401-03

- ⊕ II 2 G Ex db IIC T6, T4
- ⊕ II 2 D Ex tb III C T80 °C, T130 °C
- ⊕ I M2 Ex db I Mb

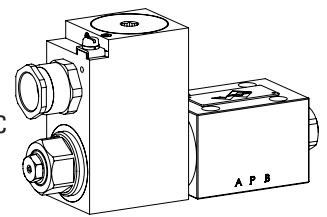

DESCRIPTION

Direct operated solenoid spool valve with 4 connections in 5 chamber design. With the solenoids deenergised, the spool is held in the center position by the spring (4/3), or switched back to the offset position (4/2). With the impulse spool (4/2), the spool is held in the switching position by the detent. The pressure tight encapsulated Ex-protection solenoid coil prevents an explosion on the inside penetrating to the outside as well as an ignitable surface temperature.

APPLICATION

These valves are suitable for applications in explosion-hazard areas, open cast and also in mines. Spool valves are mainly used for controlling direction of movement and stopping of hydraulic cylinders and motors.

SYMBOL

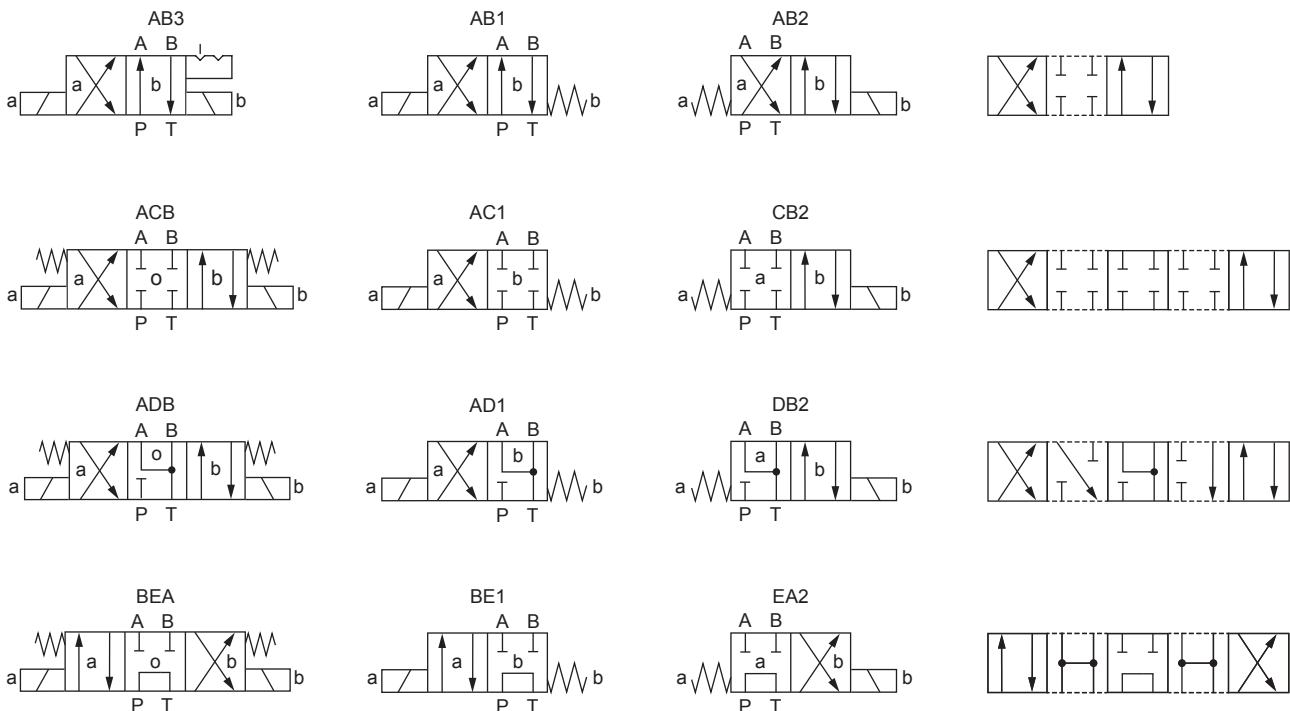

TYPE CODE

WD Y F A06 - - y - / / - Z591 #

Spool valve direct operated

Explosion proof execution Ex d

Flange construction

International standard interface ISO, NG6

Designation of symbols acc. to table

Spool clearance

Nominal voltage U_N 12 VDC 115 VAC
 24 VDC 230 VAC

Nominal power P_N 15 W

Certification ATEX, IECEx, CCC, EAC

Sealing material /
Temperature range -60...+70 °C

Design index (subject to change)

1.3-33

CERTIFICATES

	Surface	Mining	Z591 -60 °C to...
ATEX	x	x	x
IECEx	x	x	x
CCC	x	x	x
EAC	x	x	x

 The certificates can be found on www.wandfluh.com
ACTUATION

Actuation	Switching solenoid, wet pin push type, pressure tight
Execution	MKY45 / 18x60 (Data sheet 1.1-183)
Connection	Cable gland for cable Ø 6,5...14 mm

GENERAL SPECIFICATIONS

Designation	4/2-, 4/3-spool valve
Construction	Direct operated
Mounting	Flange construction
Nominal size	NG6 according to ISO 4401-03
Actuation	Ex-protection switching solenoid
Ambient temperature	Operation as T4 -60...+70 °C (L15)
Weight	2,8 kg (1 solenoid) 4,6 kg (2 solenoids)
MTTFd	150 years

HYDRAULIC SPECIFICATIONS

Working pressure	$p_{max} = 350$ bar
Tank pressure	$p_{Tmax} = 100$ bar
Maximum volume flow	$Q_{max} = 50$ l/min, see characteristics
Leakage oil	On request
Fluid	Mineral oil, other fluid on request
Viscosity range	12 mm ² /s...320 mm ² /s
Temperature range fluid	Operation as T4 -60...+70 °C (L15)
Contamination efficiency	Class 20 / 18 / 14
Filtration	Required filtration grade $\beta_{10...16} \geq 75$, see data sheet 1.0-50

ELECTRICAL SPECIFICATIONS

Protection class	IP67
Relative duty factor	100 % DF
Switching frequency	12'000 / h
Voltage tolerance	± 10 % with regard to nominal voltage
Standard nominal voltage	12 VDC, 24VDC, 115 VAC, 230 VAC AC = 50 to 60 Hz ± 2 %, with built-in two-way rectifier
Standard nominal power	15 W
Temperature class	Nominal power 15 W: T1...T4

Note! Other electrical specifications see data sheet 1.1-183



MANUAL OVERRIDE

HB6-Z591 for „-60...+70 °C“

SURFACE TREATMENT

- ◆ The valve body is made of stainless steel
- ◆ The armature tube and the plug screw are zinc-nickel coated

COMMISSIONING

Attention! The solenoid coil must only be put into operation, if the requirements of the operating instructions supplied are observed to their full extent. In case of non-observance, no liability can be assumed.



PERFORMANCE SPECIFICATIONS

Oil viscosity $\nu = 30 \text{ mm}^2/\text{s}$

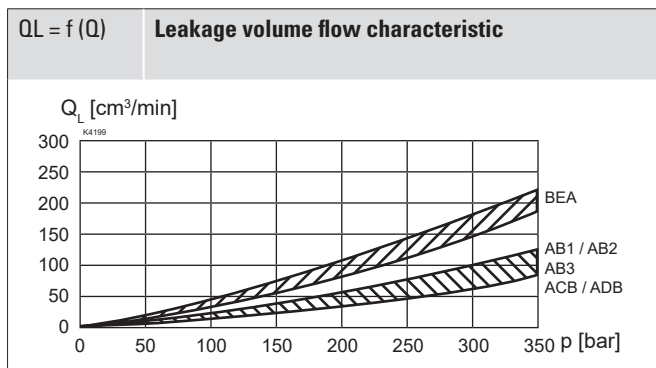
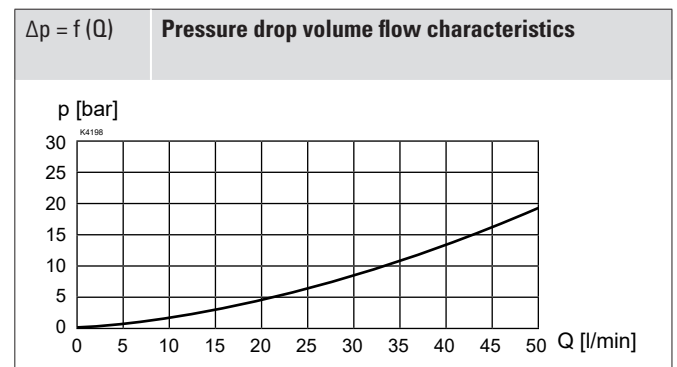
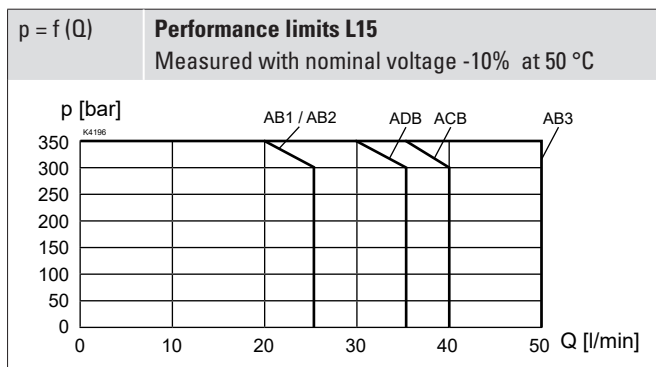

Note! With the L15 execution for ambient temperatures up to 70 °C, the performance specifications have been evaluated with an ambient temperature of 50 °C.



STANDARDS

Explosion protection	Directive 2014 / 34 / EU (ATEX)
Flameproof enclosure	EN / IEC / UL 60079-1, 31
Cable entry	EN 60079-0, 1, 7, 15, 31
Mounting interface	ISO 4401-03
Protection class	EN 60 529
Contamination efficiency	ISO 4406

ACCESSORIES

Fixing screws	Data sheet 1.0-60
Threaded subplates	Data sheet 2.9-30
Multi-station subplates	Data sheet 2.9-60
Module type manifold blocks	Data sheet 2.9-100
Technical explanations	Data sheet 1.0-100
Filtration	Data sheet 1.0-50
Relative duty factor	Data sheet 1.1-430

DIMENSIONS

4/3-way spool valve (spring centring)

4/2-way spool valve (impulse)

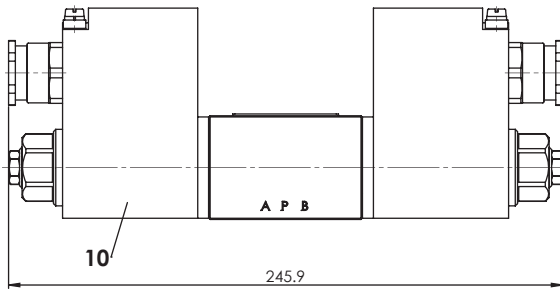

4/2-way spool valve (spring reset)

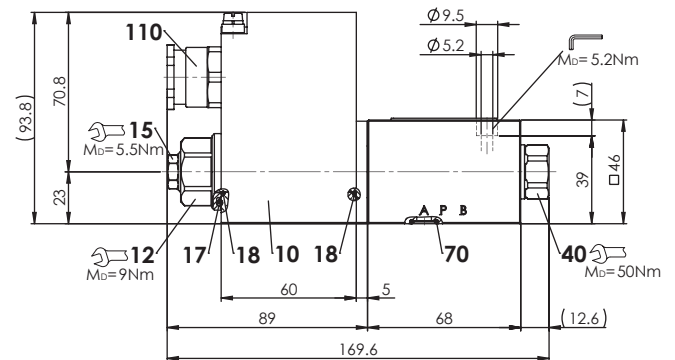

HYDRAULIC CONNECTION

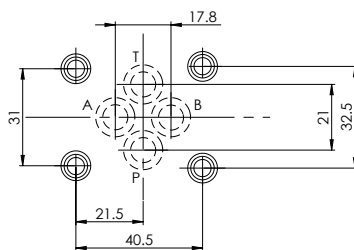

PARTS LIST

Position	Article	Description
10	263.64.. 263.68..	Solenoid coil MK.45 / 18 x 60-... / L15-M238
12	154.2603	Knurled nut Ex M18 x 1,5 x 18
15	253.8028	HB6-Z591
17	160.2251	O-ring ID 25,07 x 2,62 (NBR)
18	160.0171	O-ring ID 17,17 x 1,78 (polyurethan)
40	239.2210	Socket head screw M20 x 1
70	160.0091	O-ring ID 9,25 x 1,78 (polyurethan)
110	111.1080	Cable gland M20 x 1,5

SEALING MATERIAL

NBR as standard

INSTALLATION NOTES

Mounting type	Flange mounting 4 fixing holes for socket head screws M5 x 45
Mounting position	Any, preferably horizontal
Tightening torque	Fixing screws $M_0 = 5,1 \text{ Nm}$ (screw quality A4) $M_0 = 9 \text{ Nm}$ knurled nut

Note!

The length of the fixing screw depends on the base material of the connection element.

Attention!

For stack assembly please observe the remarks in the operating instructions