

Solenoid operated spool valve with soft switching

Flange construction

- ◆ 4/3-way with spring centred mid position
- ◆ 4/2-way with spring reset
- ◆ $Q_{max} = 20 \text{ l/min}$
- ◆ $p_{max} = 350 \text{ bar}$

NG4-Mini Wandfluh standard

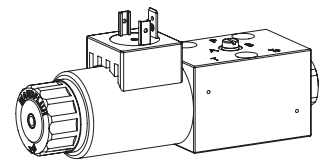

DESCRIPTION

Direct operated solenoid spool valve with 4 connections in 5 chamber design. With the solenoids deenergised, the spool is held in the center position by the spring (4/3), or switched back to the offset position (4/2). The soft switching of the valve is achieved by means of an optimum combination of the orifice and spool design. Precise spool fit, low leakage, long service life time. Spool made from hardened steel, valve body from high quality hydraulic cast steel. Wide range of standard and special voltages.

APPLICATION

Normal solenoid spool valves switch very quickly. This can lead to shocks in the hydraulic system which can cause mechanical wear and have a negative effect on operation. The soft switching valves slow down and dampen the switching movements which benefits the system. Optimum results can be achieved if all 4 connections are connected and the valve is properly vented. Miniature valves are used where both, reduced dimensions and weight are important.

SYMBOL

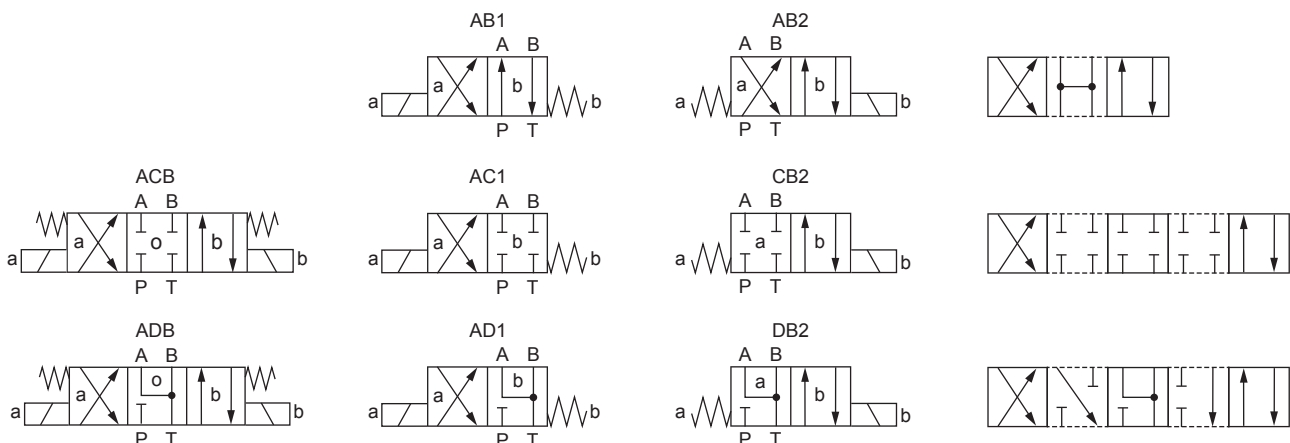

GENERAL SPECIFICATIONS

Designation	4/2-, 4/3-spool valve
Construction	Direct operated
Mounting	Flange construction
Nominal size	NG4-Mini according to Wandfluh standard
Actuation	Switching solenoid
Ambient temperature	-25...+70 °C if > +50 °C, then no undervoltage is admissible
Weight	0,90 kg (1 solenoid) 1,25 kg (2 solenoids)
MTTFd	150 years

HYDRAULIC SPECIFICATIONS

Working pressure	$p_{max} = 350 \text{ bar}$ ($p_T < 20 \text{ bar}$) $p_{max} = 315 \text{ bar}$ ($p_T > 20 \text{ bar}$)
Tank pressure	$p_{Tmax} = 100 \text{ bar}$
Maximum volume flow	$Q_{max} = 20 \text{ l/min}$, see characteristics
Leakage oil	See characteristics
Fluid	Mineral oil, other fluid on request
Viscosity range	12 mm ² /s...320 mm ² /s
Temperature range fluid	-25...+70 °C (NBR) -20...+70 °C (FKM)
Contamination efficiency	Class 18 / 16 / 13
Filtration	Required filtration grade $\beta_{10...16} \geq 75$, see data sheet 1.0-50

TYPE CODE

		W W M F A04 - <input type="text"/> - <input type="text"/> / <input type="text"/> <input type="text"/> - <input type="text"/> <input type="text"/> <input type="text"/> # <input type="text"/>									
Spool valve, soft switching											
Slip-on coil, Medium											
Flange construction											
Mounting interface acc. to Wandfluh standard, NG4-Mini											
Designation of symbols acc. to table											
Nominal voltage U_N	12 VDC	<input type="text" value="G12"/>	115 VAC	<input type="text" value="R115"/>							
	24 VDC	<input type="text" value="G24"/>	230 VAC	<input type="text" value="R230"/>							
	without coil	<input type="text" value="X5"/>									
Slip-on coil	Metal housing, round with one-sided collar	<input type="text" value="V"/>	(only G12 and G24)								
	Metal housing, square with one-sided collar	<input type="text" value="N"/>									
Connection execution	Connector socket EN 175301-803 / ISO 4400	<input type="text" value="D"/>									
	Connector socket AMP Junior-Timer	<input type="text" value="J"/>	(only for $U_N \leq 75$ VDC)								
	Connector Deutsch DT04 - 2P	<input type="text" value="G"/>	(only for $U_N \leq 75$ VDC)								
Sealing material	NBR	<input type="text"/>									
	FKM (Viton)	<input type="text" value="D1"/>									
Manual override	Integrated	<input type="text"/>									
	Push-button	<input type="text" value="HF1"/>									
	Spindle	<input type="text" value="HS1"/>									
Orifice diameter	\emptyset 0.3 mm (Standard)	<input type="text"/>									
Design index (subject to change)											

1.4-13

ELECTRICAL SPECIFICATIONS

Protection class	Connection execution D: IP65 Connection execution J: IP66 Connection execution G: IP67 and IP69K
Relative duty factor	100 % DF
Switching frequency	Since switching is damped and slow, switching frequency is of secondary importance.
Service life time	10^7 (number of switching cycles, theoretically)
Voltage tolerance	± 10 % with regard to nominal voltage
Standard nominal voltage	12 VDC, 24VDC, 115 VAC, 230 VAC AC = 50 to 60 Hz, rectifier integrated in the connector socket

Note! Other electrical specifications see data sheet 1.1-168 (slip-on coil V) and 1.1-175 (slip-on coil N)

SURFACE TREATMENT

- ◆ The valve body is painted with a two component paint
- ◆ The screw plug, the slip-on coil and the armature tube are zinc-nickel coated

COMMISSIONING

Attention! When commissioning, the valve must be vented under pressure (max. two rotations of screw E).

STANDARDS

Mounting interface	Wandfluh standard
Solenoids	DIN VDE 0580
Connection execution D	EN 175301 – 803
Protection class	EN 60 529
Contamination efficiency	ISO 4406

SEALING MATERIAL

NBR or FKM (Viton) as standard, choice in the type code

ACTUATION

Actuation	Switching solenoid, wet pin push type, pressure tight
Execution	V.E37 / 19 x 50 (Data sheet 1.1-168) N.S35 / 19 x 50 (Data sheet 1.1-175)
Connection	Connector socket EN 175301 – 803 Connector socket AMP Junior-Timer Connector Deutsch DT04 – 2P

MANUAL OVERRIDE

- ◆ Integrated (–) Actuation pin integrated in the armature tube. Actuation by pressing the pin
- ◆ Push-button (HF1) Integrated in the knurled nut. Actuation by pressing the push-button
- ◆ Spindle (HS1) Integrated in the knurled nut. Actuation by turning the spindle (continuously variable valve actuation)

Attention! The actuation of the manual override is possible up to a tank pressure of:
 40 bar Integrated (–)
 40 bar Push-button (HF1)
 100 bar Spindle (HS1)

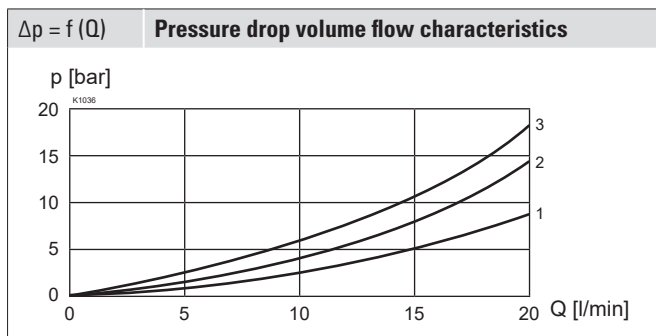
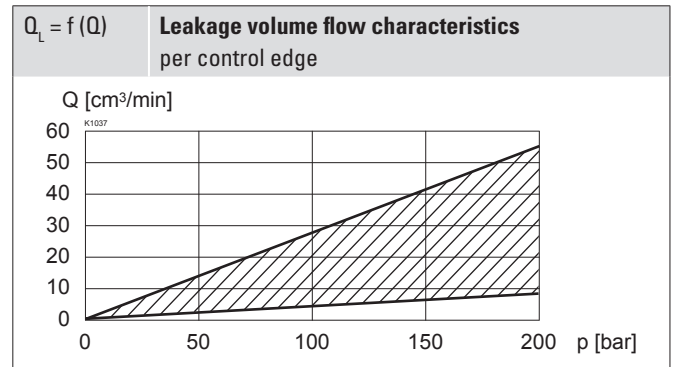
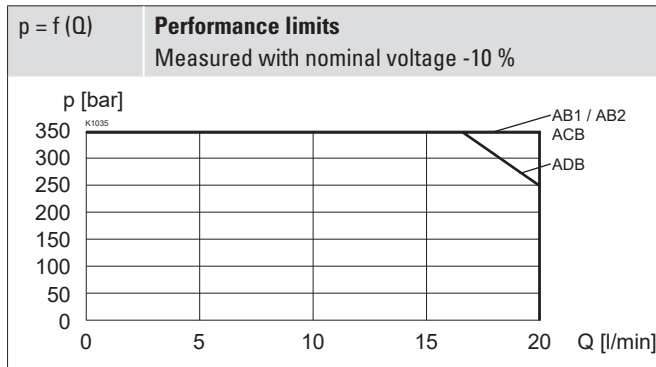

PERFORMANCE SPECIFICATIONS

 Oil viscosity $\nu = 30 \text{ mm}^2/\text{s}$

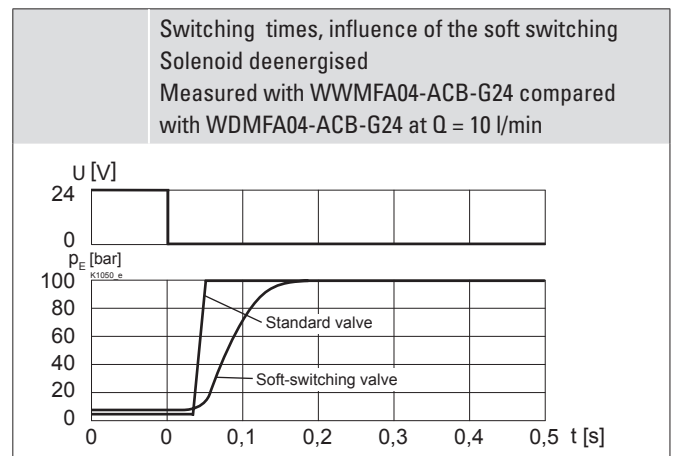
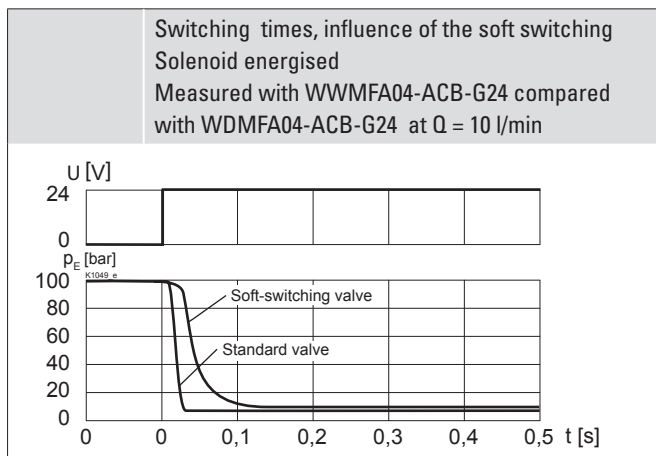
Symbol	Volume flow direction				
	P - A	P - B	P - T	A - T	B - T
AB1 / AB2	3	3	-	3	3
ACB / AC1 / CB2	2	2	-	2	2
ADB / AD1 / DB2	3	3	-	1	1

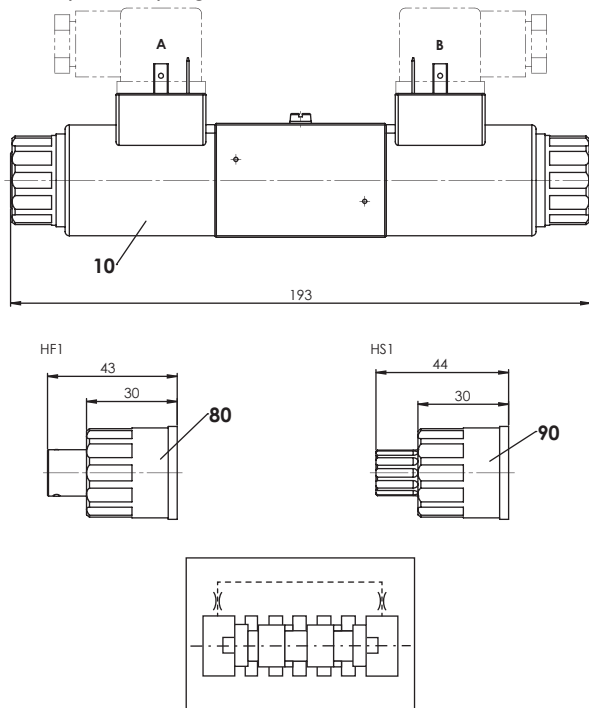
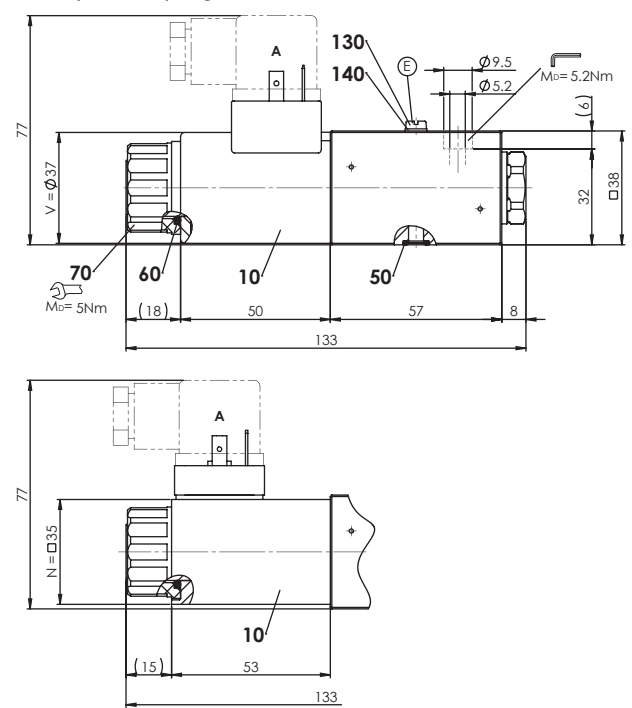

DIMENSIONS

4/3-way valve (spring centred)

4/2-way valve (spring reset)

E = Air bleed screw

Orifices in valve body influence the switching times

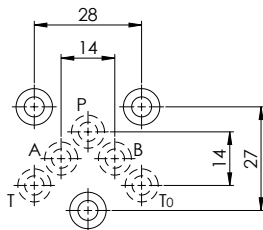
HYDRAULIC CONNECTION



ACCESSORIES

Mating connector grey (A)	Article no. 219.2001
Mating connector black (B)	Article no. 219.2002
Mounting screws	Data sheet 1.0-60
Threaded subplates	Data sheet 2.9-10
Multi-station subplates	Data sheet 2.9-50
Horizontal mounting blocks	Data sheet 2.9-90
Technical explanations	Data sheet 1.0-100
Filtration	Data sheet 1.1-50
Relative duty factor	Data sheet 1.1-430

PARTS LIST

Position	Article	Description
10	206.2... 260.5...	V.E37 / 19 x 50 N.S35 / 19 x 50
50	160.2052 160.6052	O-ring ID 5,28 x 1,78 (NBR) O-ring ID 5,28 x 1,78 (FKM)
60	160.2187	O-ring ID 18,72 x 2,62 (NBR)
70	154.2700	Knurled nut
80	253.7001	Push-button
90	253.7000	Spindle
130	246.1007	Socket head screw zinc-coated blue M4 x 6 DIN84 A
140	049.2040	Bonded seal ID 4,1 x 7,2 x 1

INSTALLATION NOTES

Mounting type	Flange mounting 3 fixing holes for socket head screws M5 x 40
Mounting position	Any, preferably horizontal
Tightening torque	Fixing screws $M_D = 5,2 \text{ Nm}$ (screw quality 8.8, zinc coated) $M_D = 5 \text{ Nm}$ knurled nut

Note!

The length of the fixing screw depends on the base material of the connection element.