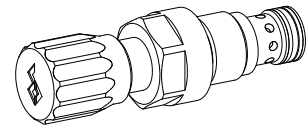

**Pressure relief valve
Screw-in cartridge**

- Direct operated
- $Q_{max} = 100 \text{ l/min}$
- $p_{max} = 100 \text{ bar}$
- $p_{Nmax} = 32 \text{ bar}$

M22x1,5
 ISO 7789

DESCRIPTION

Directly operated pressure relief valve in screw-in cartridge construction with M22x1,5 thread for cavity acc. to ISO 7789. The valve is available with two different types of adjustment: key adjustment «S» and control knob adjustment «D». Key adjustment «S» is also available with cover, see data sheet 2.0-50. One pressure stage, 32 bar, is available as standard. The cartridge body made of steel is galvanized and therefore rust-protected.

FUNCTION

The adjustment mechanism keeps the control spool in its end position by means of a coil spring. When the set operating pressure has been reached, the main spool opens and connects the protected line with the return to the tank. This means that the pressure occurring in P is relieved to T until the spring force returns the valve spool to its end position.

APPLICATION

For hydraulic systems with low operating pressures and high volume flows to limit the operating pressure by diverting the flow of the oil from the protected line P (1) to the outlet/tank line T (2). The screw cartridges are very well suited for installation in control blocks and are installed as a functioning part in Wandfluh hydraulics NG4, NG6 and NG10 sandwich plates (vertical stacking) and flange valves (please see separate data sheets in register 2.1). Cavity tools are available (for hire or purchase) for the manufacture of cartridge cavities in steel or aluminium blocks. See data sheets in register 2.13.

Attention: Should therefore not be utilized anymore in applications with periodically changing direction of flow.

TYPE CODE

Pressure relief valve	B	K	<input type="checkbox"/>	PM22	-	32	#	<input type="checkbox"/>
Direct operated, control spool								
Type of adjustment	Key	<input checked="" type="checkbox"/>	S					
	Control knob	<input type="checkbox"/>	D					
	Cover	<input type="checkbox"/>	A	(see data sheet 2.0-50)				
Screw cartridge M22x1,5								
Pressure range p_N	32 bar							
Design-Index (Subject to change)								

GENERAL CHARACTERISTICS

Description	Directly operated pressure relief valve
Construction	Screw-in cartridge for cavity acc. to ISO 7789
Type of fixture	M22x1.5 screw thread
Ambient temperature	-20...+50 °C
Installation position	any
Tightening torque	$M_D = 50 \text{ Nm}$
Weight	$m = 0,18 \text{ kg}$ (key) $m = 0,19 \text{ kg}$ (control knob)

HYDRAULIC CHARACTERISTICS

Hydraulic fluid	Mineral oils, other fluids on request
Max permissible contamination level	ISO 4406:1999, class 18/16/13 (recommended filter gauge $\beta_{6...10} \geq 75$) see data sheet 1.0-50/2
Viscosity range	12 mm ² /s...320 mm ² /s
Hydraulic fluid temp.	-20...+70 °C
Peak pressure	$p_{max} = 100 \text{ bar}$ $p_{Tmax} = p_p + 20 \text{ bar}$ $p_N = 32 \text{ bar}$
Rated pressure stage	
Minimum pressure	see curve
Volume flow	$Q = 0,2...100 \text{ l/min}$
Leak volume flow	see curve

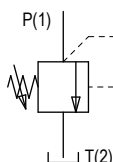
SYMBOL

MECHANICAL ACTUATION

Mechanical types of operation in 2 different versions:

S	= Screw adjustment with fork wrench and Allen key
D	= Control knob adjustment, fixed
Actuation stroke S_b	= 7 mm
Actuation angle α_b	= 2520° (7 revolutions)

CHARACTERISTICS Oil viscosity $\nu = 30 \text{ mm}^2/\text{s}$

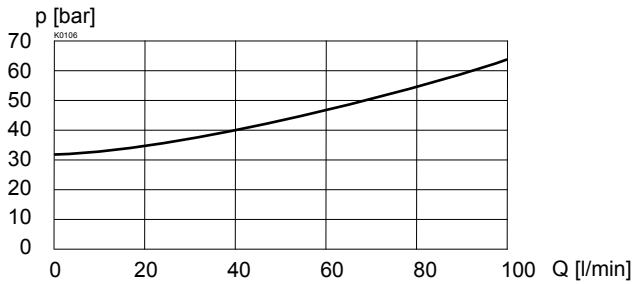
$p = f(Q)$ Pressure volume flow characteristics
(Maximal adjustable pressure)



$p = f(Q)$ Pressure volume flow characteristics
(Minimal adjustable pressure)

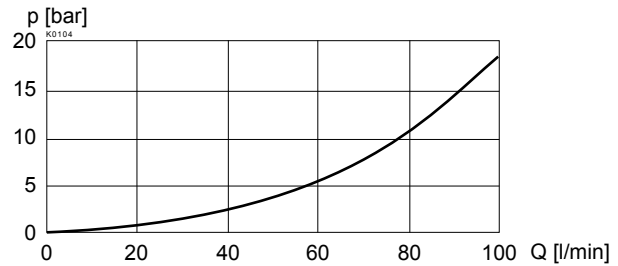

$p = f(n)$ Pressure adjustment characteristics
(at $Q = 5 \text{ l/min}$)

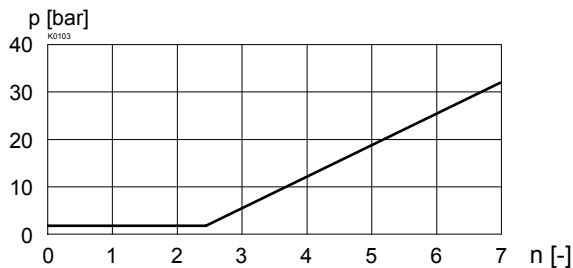

$Q_L = f(p)$ Leakage volume flow characteristics
[P (1) → T (2)]

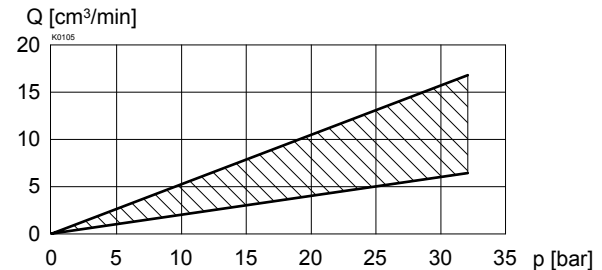
DIMENSIONS

Screw adjustment «S»

Knob adjustment «D»

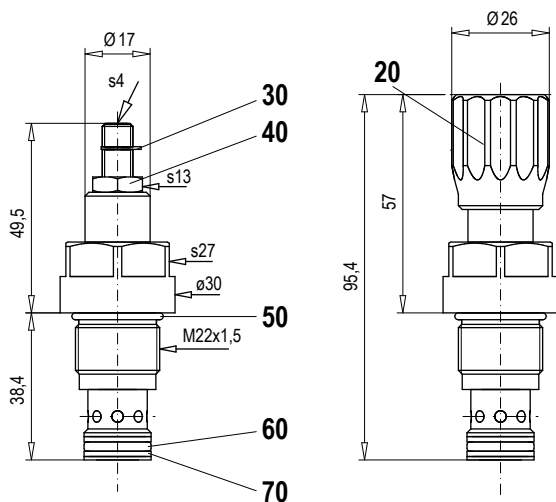
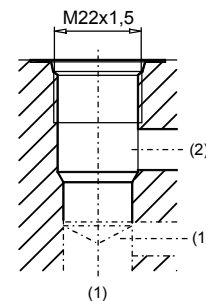
 Cavity drawing to
ISO 7789-22-02-0-98

Detailed cavity drawing and cavity tools see data sheet 2.13-1003.

PARTS LIST

Position	Article	Description
20	114.2224	Knob
30	193.1061	Safety plate RD6 DIN 6799
40	153.1402	Hexagonal nut 0,5D M8 x 1
50	160.2188	O-ring ID 18,77 x 1,78
60	160.2140	O-ring ID 14,00 x 1,78
70	049.3177	Back-up ring RD 14,6 x 17,5 x 1,4

ACCESSORIES

Pressure relief valve:

Flange-/sandwich plate NG4-Mini

Data sheet 2.1-620

Flange-/sandwich plate NG6

Data sheet 2.1-640

Flange-/sandwich plate NG10

Data sheet 2.1-660

Back pressure valve:

Sandwich plate NG4-Mini

Data sheet 2.1-720

Sandwich plate NG6

Data sheet 2.1-740

Sandwich plate NG10

Data sheet 2.1-760

Line mount body

Data sheet 2.9-200

Technical explanation see data sheet 1.0-100