

**Cavity for poppet valve cartridge NG3**

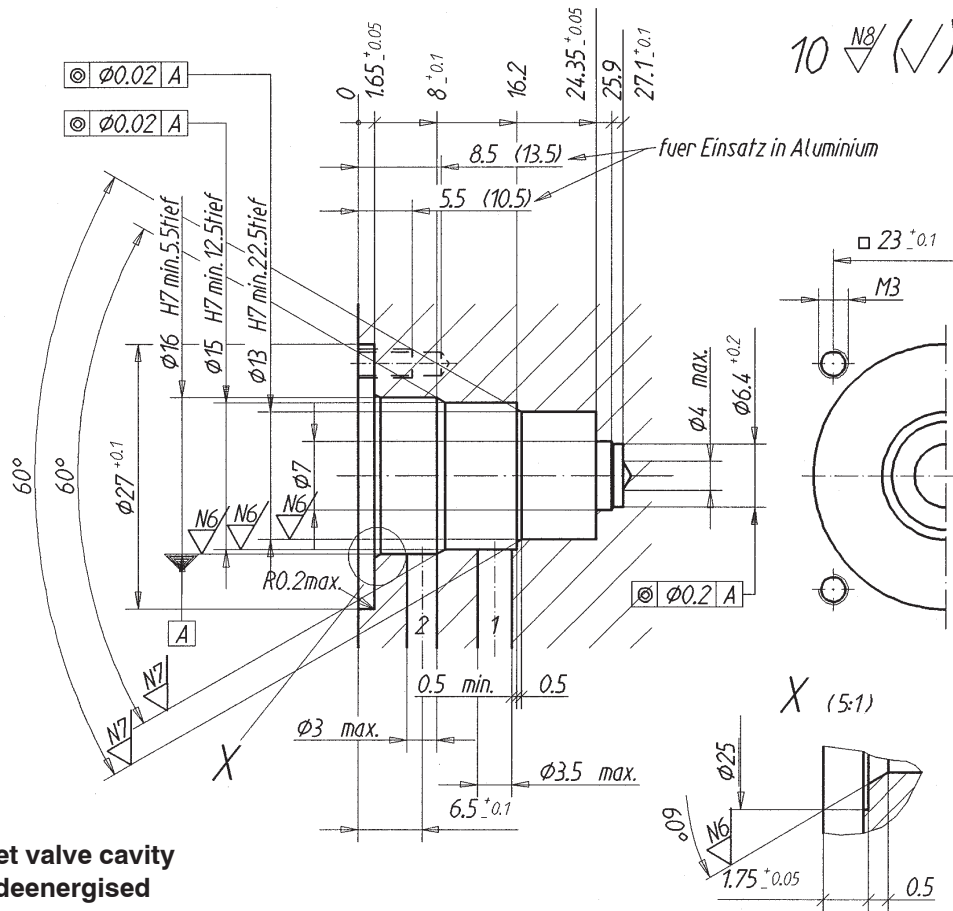

**2-way poppet valve cavity  
open when deenergised**

(Drawing no. 1-1293.4)

**Cavity tools**

**Denomination:**

Form drill  
Form reamer

**Article number:**

983.2107  
983.2207

**Form tool set**

consisting of; form drill and form reamer

983.2805

**Application**

**Cartridge type:**

.22030-S1265-...

**Data sheet number:**

1.11-2015

**Cartridge type:**

**Data sheet number:**