

**Cavity for poppet valve cartridge NG4**

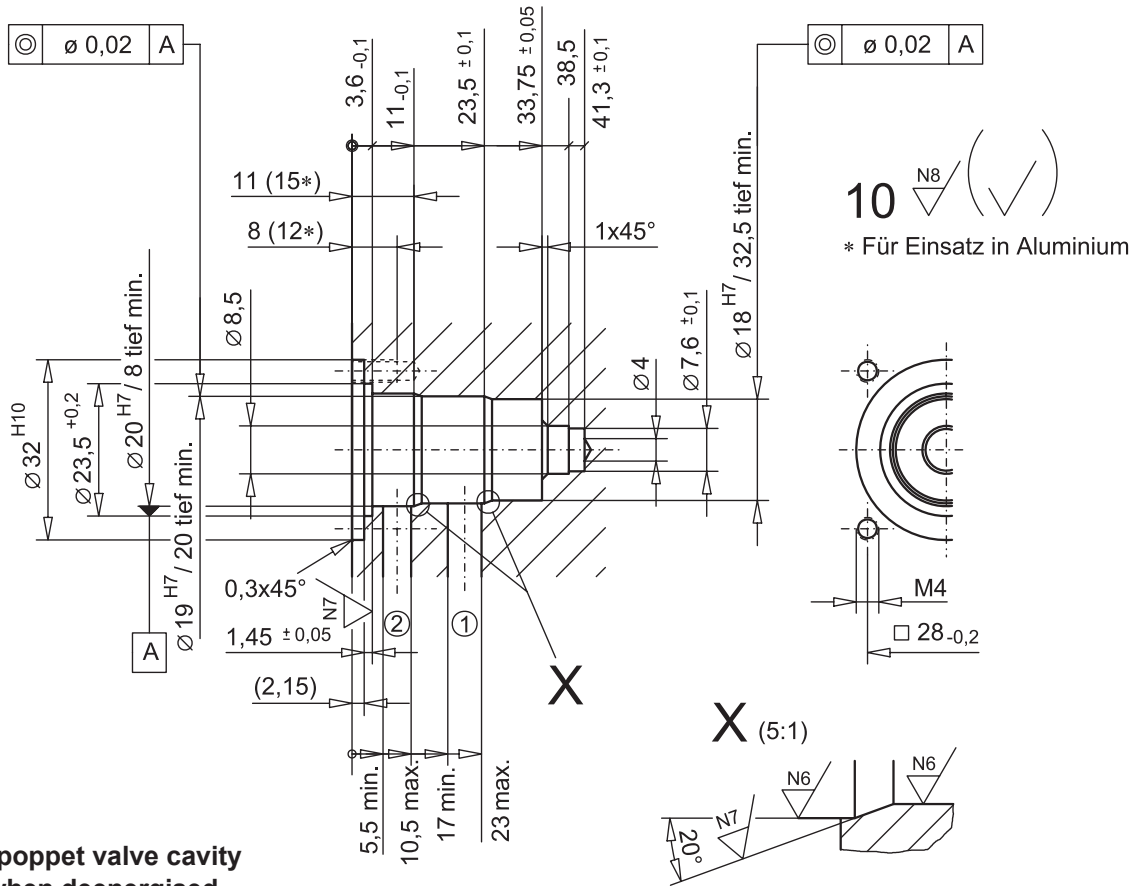

**2-way poppet valve cavity  
open when deenergised**

(Drawing no. 5-2711.4)

**Cavity tools**

**Denomination:**

Form drill  
Form reamer

**Article number:**

983.2104  
983.2204

**Form tool set**

consisting of; form drill and form reamer

983.2800

**Application**

**Cartridge type:**

.22040-S1265-...

**Data sheet number:**

1.11-2025

**Cartridge type:**

**Data sheet number:**